

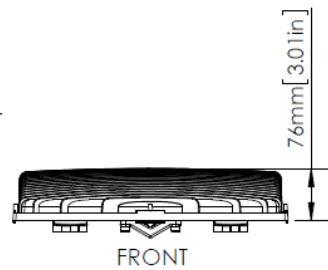

Apollo SL5 medium AMBER – This is the AMBER version of our standard medium traffic light for applications close to the coast. The robust die cast aluminum housing with its finned surface guarantees excellent heat management. The light is ETL listed and conforms to UL STD 1598.

- for street, roadway and parking lot lighting applications
- heat management system assures long LED life and minimal lumen depreciation
- tool-less entry for ease of maintenance
- modular LED design with the ability to easily replace LEDs in the field
- universal mounting design
- best lumens per watt/lumen per dollar in the industry
- mil-spec components to withstand the hottest and coldest climates
- wireless control, UHF or 900 MHz
- optional: Camera, WiFi, LTE, and DVR

Number of LEDs	8/16/24
Lumen@623nm	6000/12000/18000
Lumen per Watt	114
Typical Power Consumption (W)	62/124/220

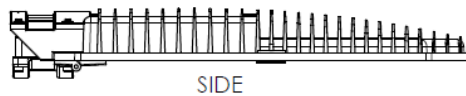
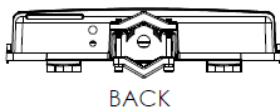
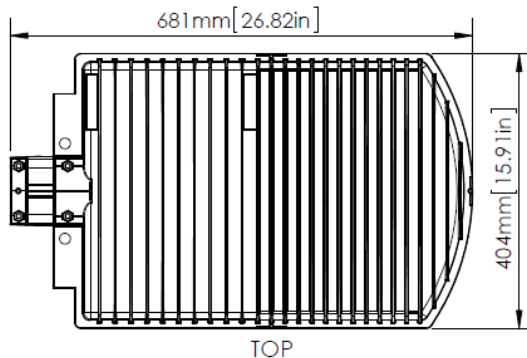
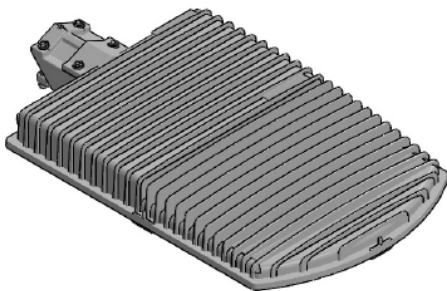

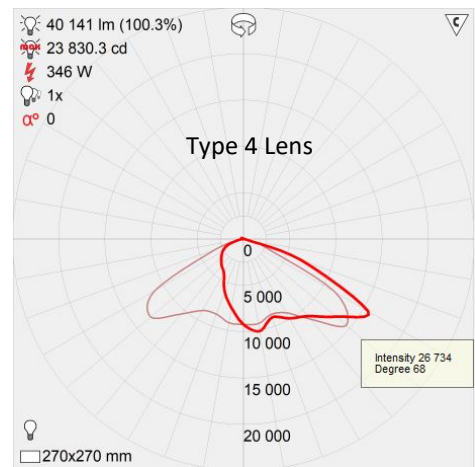
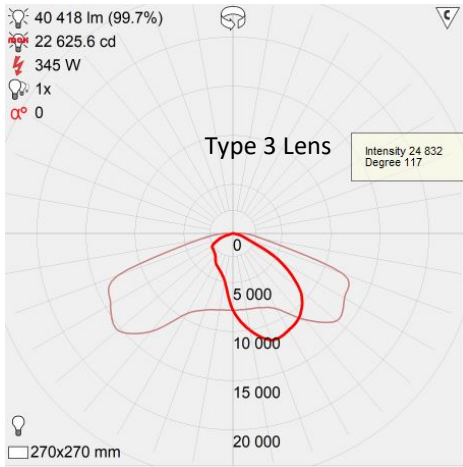

Electrical	
Input Voltage	100-277 V AC or 480 V AC
Frequency Range	50/60 Hz
Driver	Inventronics
Surge Spike Protection	Inventronics PS-20KS10KHT Imax 20 kA, In 10 kA, UL1449 recognized
Electrical Rating	UL1598/ETL
Power Factor	0.99
Optical	
Light Source	OSRAM LZ4-00R108
Color Temperature	623 nm
Custom Design Lens Source	LEDIL
Beam Pattern	Type III, IV or V, others on request
Lumen/Watt	114
Environmental	
Operating Temperature	-40 to +85C
Rating	IP66
Mechanical	
Dimensions	681 x 404 x 76 mm
Weight	18.8 Lbs. (8.5 kg)
Material	Aluminum Alloy / Glass
Coating	Polyester Powder Coating Light grey RAL7035
Wind Load	0.056 m ² = 0.557 sqft
Mounting	Diameter 2.6"/63 mm